



LIVEWORX 23

A NEW ERA IN PRODUCT LIFECYCLE INNOVATION

TRACK SPOTLIGHT

PLM

Mark Lobo

SVP and General Manager, PTC PLM

Helmut Huprich

VP Engineering Applications, Schaeffler AG

Lasse Lundberg Nowack

Head of Engineering Development, Vestas Wind Systems A/S

Reggie Fortson

Senior Director PLM AND Advanced Engineering, Johnson & Johnson

PRODUCT LIFECYCLE INNOVATION WITH WINDCHILL AND WINDCHILL+

LIVEWORX.COM | #LIVEWORX

6 9 8 3
7 8 4 6
8 0 1 2
3 8 3 4

PASSTHROUGH :A13

C23xU321x

plm to **PLM**

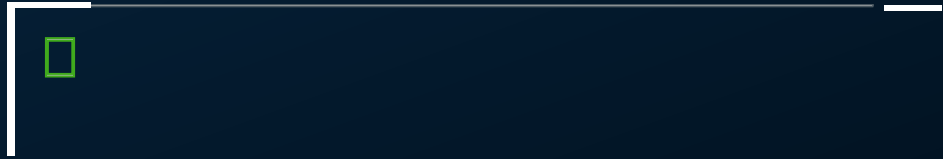

GROW FAST

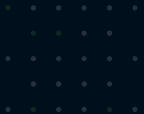
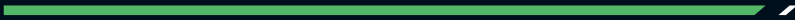
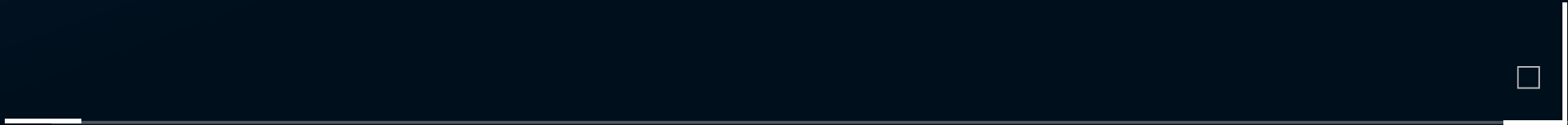

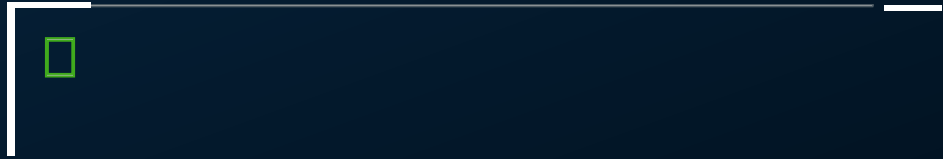

OPTIMIZE **EVERYTHING**

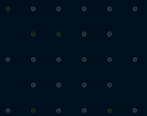
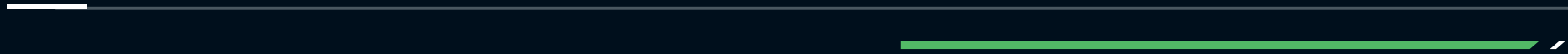
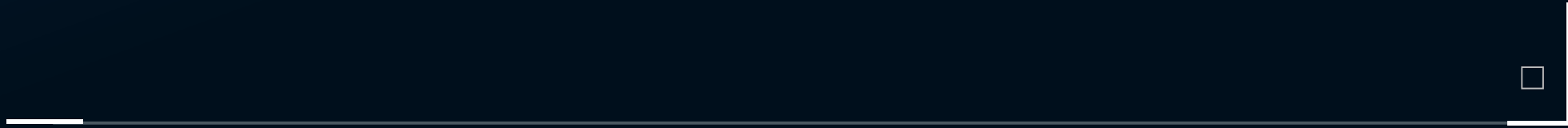

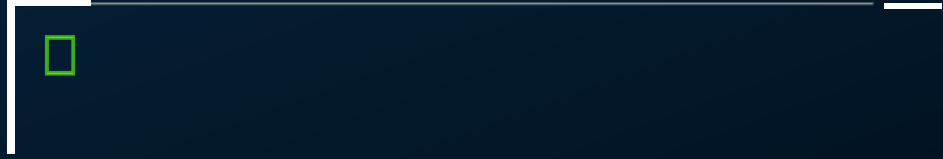

SCALE **GLOBALLY**

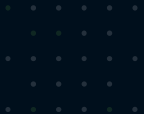
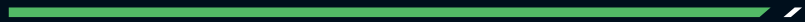
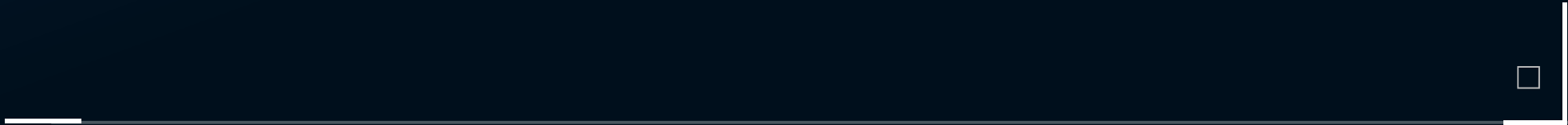

SCHAEFFLER



GROW **FAST**

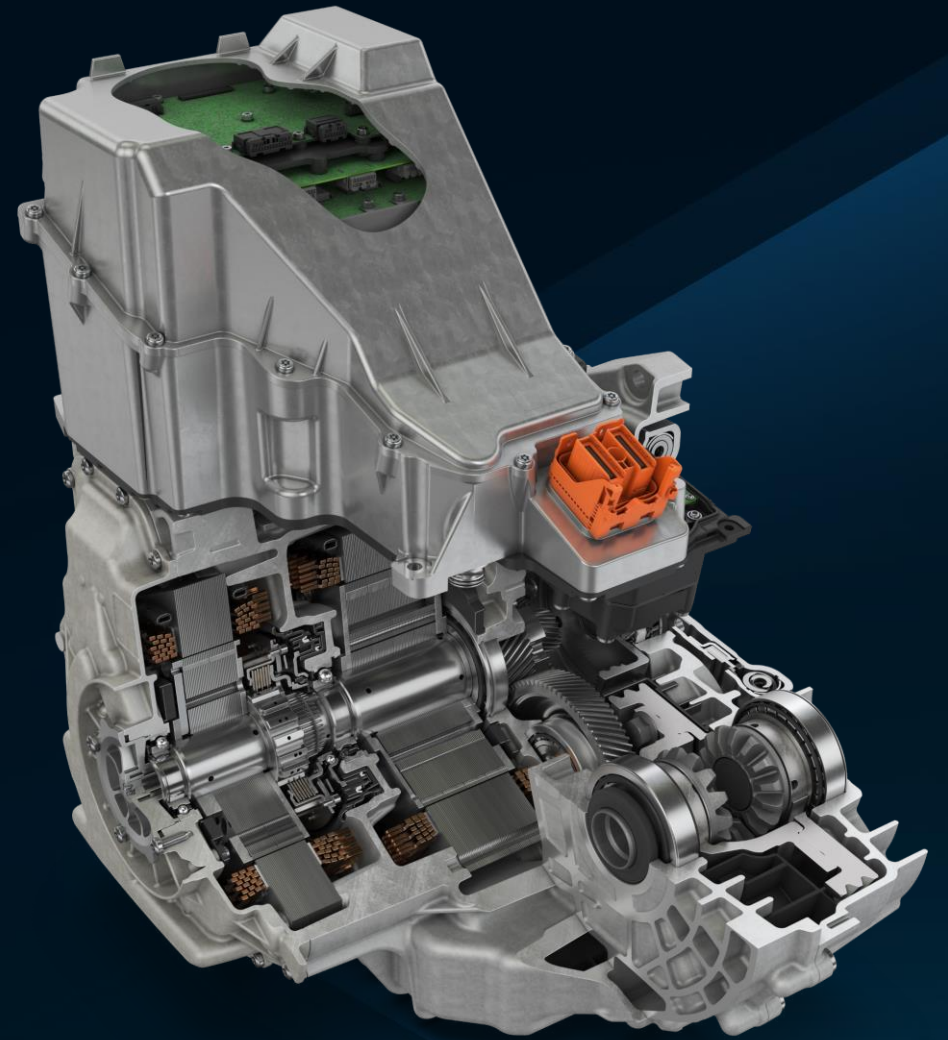

Vestas[®]



OPTIMIZE EVERYTHING



Johnson & Johnson

MEDTECH



SCALE **GLOBALLY**





windchill+™

ACCELERATE...

INNOVATION
ADOPTION
VALUE

SO, YOU CAN...

GROW **FAST**

OPTIMIZE **EVERYTHING**

SCALE **GLOBALLY**

Share



Learn



Experience





LIVEWORX 23

A NEW ERA IN PRODUCT LIFECYCLE INNOVATION

THANK YOU

[LIVEWORX.COM](https://www.liveworx.com) | [#LIVEWORX](https://twitter.com/liveworx)